

# P 131 Duschrinne CeraWall Individual + Ablaufgehäuse DallFlex Plan + Schallschutz

## Shower channel CeraWall Individual + drain body DallFlex Plan + soundproofing

Anschluss seitlich, Verbundabdichtung, Schallschutz / Side outlet, under-tile waterproofing, soundproofing

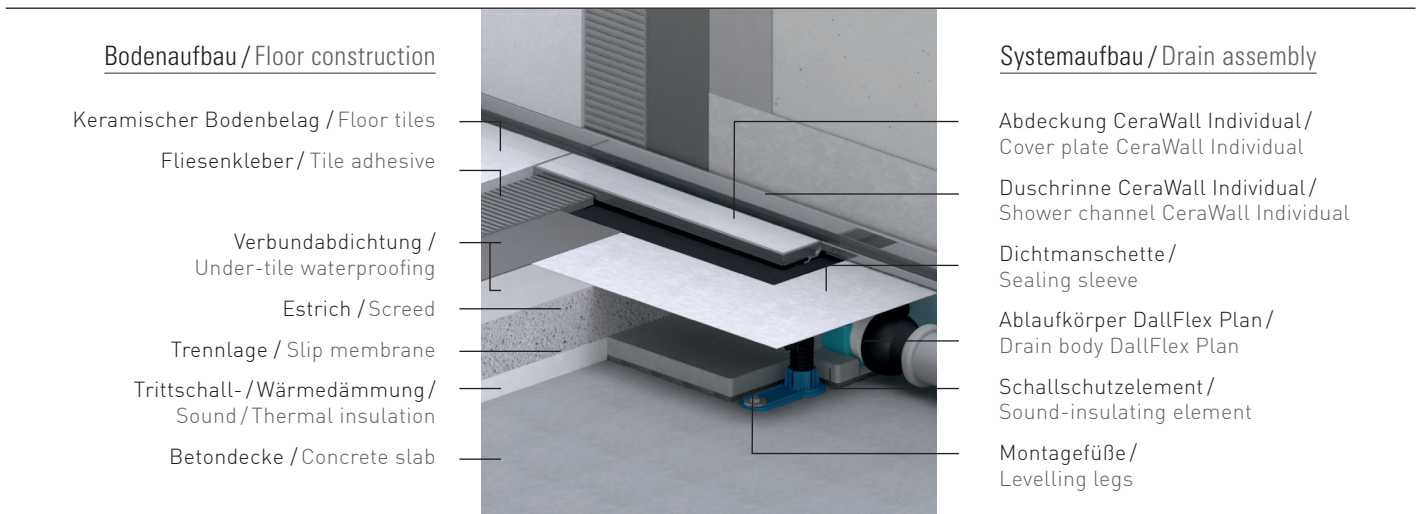

### Duschrinne CeraWall Individual / Shower channel CeraWall Individual

- Länge: 800 mm
- Mit eingefrästem Quergefälle
- Flächenbündige, offene Wasserführung
- Geeignet für Wand- und Bodenbeläge von 12 - 24 mm (inkl. Kleberbett)
- Length: 800 mm
- With integrated cross-fall
- Flush, exposed channel flow
- Suitable for wall and floor finish 12 to 24 mm (including adhesive)

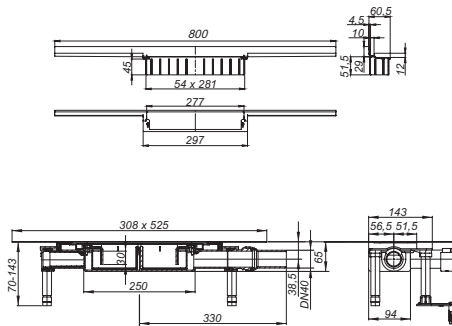

### Ablaufgehäuse DallFlex Plan / Drain body DallFlex Plan

- Maße: 445 x 143 mm
- Bauhöhe: 70 mm
- Bodenaufbau: 70 - 143 mm
- Dimensions: 445 x 143 mm
- Build-in height: 70 mm
- Floor structure: 70 to 143 mm

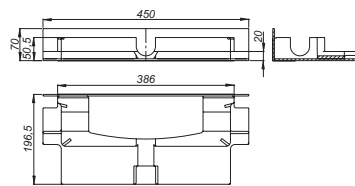

### Schallschutzelement DallFlex Plan / Sound-insulating element DallFlex Plan

Bei Einbau gemäß Prüfbericht P-BA 144/2015 geeignet zur Erfüllung der erhöhten Schallschutzanforderungen nach DIN 4109 (≤ 18 dB) / VDI 4100 (≤ 14 dB).  
 Tested to conform to DIN 4109 (≤ 18 dB) / VDI 4100 (≤ 14 dB), certificate P-BA 144/2015.

### Ihre Berechnung / Your calculation

Bodenbelag / Floor slab			mm
Estrich (mind. 55 mm) / Screed (min. 55 mm)	+		mm
Trittschalldämmung (mind. 30 mm) / Sound insulation (min. 30 mm)	+		mm
Schallschutzelement / Sound-insulating element	+		20 mm
Aufbau gesamt / Construction height	=		mm
			<b>≥ 97 mm, ≤ 167 mm</b>

Bodenaufbau 70 - 143 mm → 12 - 24 mm

### Ausführung / Standard details

	DN 40	Kunststoff Plastic			0,5 l/s	R 30/60/90/120	DIN 18534	1		L 15
	DN 70						DIN 18534	2		K 3
	DN 100							10 x 800 mm	R 12	
									B	

Gewicht: 5,78 kg / weight: 5.78 kg

Legende Piktogramme Seite 3 / legend icons page 3

## Einsatzbereich:

### Bodengleiche Dusche/Nassraum

Die wasserableitende Einheit der Duschrinne CeraWall Individual liegt oberhalb der Verbundabdichtungen gemäß DIN 18534, grundsätzlich vorzusehen bei Boden- und Wandflächen im direkt beanspruchten Bereich (z. B. Wände im Duschbereich, Fußböden bodengleicher Duschen).

## Farbvarianten CeraWall Individual

Die Duschrinne CeraWall Individual ist in vier Farbvarianten erhältlich: Edelstahl matt, Anthrazit matt, Rotgold matt und Messing matt.

## Baulängen

800 – 2000 mm, millimetergenau anpassbar (farbige Varianten bis 1200 mm).

## Installation detail:

### Level access showers and wet rooms

Using CeraWall Individual means the water draining component is always entirely above the tanking layer.

## Colour variants CeraWall Individual

The shower channel CeraWall Individual is available in four colour variants: stainless steel matt, anthracite matt, red gold matt and brass matt.

## Lengths

800 to 2000 mm, can be adjusted in length accurate to the millimetre (colour versions up to 1200 mm).



CeraWall Individual matt / matt



CeraWall Individual anthrazit / anthracite matt



CeraWall Individual rotgold / red gold matt



CeraWall Individual messing / brass matt

## Abdeckungen CeraWall Individual / CeraWall Individual cover plate

Zur Duschrinne CeraWall Individual muss, abhängig von der Beschaffenheit des Bodenbelages, eine der drei Abdeckungen ausgewählt und separat mitbestellt werden:

Depending on the flooring specifications, one of the three cover plates has to be selected and ordered separately with the CeraWall Individual shower channel:



Individual: zum Befliesen mit Bodenbelägen, deren Schnittkanten nicht poliert werden (alle Farben).  
Individual: for flooring with unfinished cut edges (all colours).



Naturstein: zum Befliesen mit Bodenbelägen, deren Schnittkanten poliert werden können oder die durchgefärbt sind.  
Natural stone: for flooring with polished cut edges or self-colour floor finish.



Design: universell einsetzbares Edelstahldesign, wird nicht befliesen (alle Farben).  
Design: all-purpose design in stainless steel design, not to be tiled (all colours).

ARTIKEL ARTICLE	ART. NR. PART NO.	KATALOG CATALOGUE	SEITE PAGE
<b>Ablaufgehäuse DallFlex Plan / Drain body DallFlex Plan</b> Material: Polypropylen, hochschlagfest, mit Kugelgelenk, verstellbar von 0 – 15 Grad Material: polypropylene, ball-joint adjustable 0 – 15 degrees	539014	Neue Badwelten New bathroom landscapes	32 30
<b>Duschrinne CeraWall Individual 800 mm / Shower channel CeraWall Individual 800 mm</b> Edelstahl matt: Edelstahl 1.4301 / Stainless steel matt: 304 stainless steel Anthrazit matt: Edelstahl 1.4301, farbig PVD-beschichtet / Anthracite matt: 304 stainless steel, PVD coating Rotgold matt: Edelstahl 1.4301, farbig PVD-beschichtet / Red gold matt: 304 stainless steel, PVD coating Messing matt: Edelstahl 1.4301, farbig PVD-beschichtet / Brass matt: 304 stainless steel, PVD coating	535269 535603 536891 536945	Neue Badwelten New bathroom landscapes	84 – 91 78 – 85
<b>Abdeckungen CeraWall Individual / Cover plate CeraWall Individual</b> Individual: Edelstahl matt (535023), Anthrazit matt (537003), Rotgold matt (537027), Messing matt (537041) / Individual: Stainless steel matt (535023), Anthracite matt (537003), Red gold matt (537027), Brass matt (537041) Naturstein: Edelstahl matt (535030) / Natural stone: Stainless steel matt (535030) Design: Edelstahl matt (535047), Anthrazit matt (537010), Rotgold matt (537034), Messing matt (537058) / Design: Stainless steel matt (535047), Anthracite matt (537010), Red gold matt (537034), Brass matt (537058)		Neue Badwelten New bathroom landscapes	92 86
<b>Schallschutzelement DallFlex Plan / Sound-insulating element DallFlex Plan</b>	539106	Neue Badwelten New bathroom landscapes	32 30

Im Lieferumfang enthalten: Ablaufgehäuse mit integrierter Estrichverankerung, vorgefertigter Randdämmstreifen, schallentkoppelte Justierschrauben zur Höhenverstellung, herausnehmbarer Geruchs- und Reinigungsverschluss, Bauschutzdeckel, Dichtmanschette













Bestellhinweis: Bitte Ablaufgehäuse DallFlex Plan + Duschrinne CeraWall Individual + Abdeckung CeraWall Individual + Schallschutzelement DallFlex Plan bestellen!

Included: Drain body with integrated anchors for extra grip in the screed, sound absorbing and height-adjustable levelling legs, removable trap insert, temporary blanking plate, sealing sleeve  
Order note: Please order drain body DallFlex Plan + shower channel CeraWall Individual + cover plate CeraWall Individual + sound-insulating element DallFlex Plan as four components!

Download DXF: [www.dallmer.de/dxf](http://www.dallmer.de/dxf)  
BIM Daten: [www.dallmer.de/bim](http://www.dallmer.de/bim)  
Gebührenfreie Infoline: + 49 800 (DALLMER) 3255637  
Ausschreibungstexte: [www.dallmer.de/ausschreiben](http://www.dallmer.de/ausschreiben)

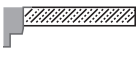
Download DXF: [www.dallmer.de/en/dxf](http://www.dallmer.de/en/dxf)  
BIM files: [www.dallmer.de/en/bim](http://www.dallmer.de/en/bim)  
Freephone infoline: + 49 800 (DALLMER) 3255637

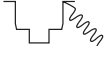
# Piktogramme / Icons

	Ablaufgehäuse senkrecht/seitlich	floor drain body vertical/horizontal
	mit/ohne Geruchsverschluss	with/without trap
DN 50, DN 70, DN ...	Nennweite	nominal diameter
Kunststoff, Edelstahl plastic, stainless steel	Material des Ablaufgehäuses	drain body material
	Ablaufleistung	flow rate
<b>R</b> 30/60/90/120	Brandschutz	fire protection
1  2 	ein oder zwei Abdichtungsebenen	one or two waterproofing membranes
DIN 18534	Verbundabdichtung gemäß DIN 18534	waterproofing confirming to DIN 18534 or other approved standard
 150×150 mm	Rost mit/ohne Verschraubung, Rahmengröße	grate secured /not secured, dimension of frame
	CeraNiveau Aufsatz	CeraNiveau grating
	CeraLine Abdeckungen, Standard, Design und Individual	CeraLine cover plate, Standard, Design and Individual
	Duschrinne CeraFloor Select	shower channel CeraFloor Select
	Duschrinne CeraWall Select	shower channel CeraWall Select
	Duschrinne CeraWall Individual	shower channel CeraWall Individual
L 15 K 3 R 12 B	Belastungsklassen Aufsatz mit Rost: L 15 – 1,5 t K 3 – 300 kg R 12 – rutschhemmend B – rutschhemmend	Loadings: L 15 – 1.5 t K 3 – 300 kg R 12 – non slip B – non slip
	Betondecke	concrete
	Trapezblechdecke	profiled steel
 Druckstrom/Siphonic	SuperDrain® Druckstromentwässerung	SuperDrain® siphonic roof drainage
 beheizt 230V/heated 230V	Ablaufgehäuse beheizt 230V-Stromanschluss	heated drain body 230V-operating voltage
	Frostsichere Geruchssperre, Pendelklappe	frost-proof self-closing flap-valve