

shower channel CeraLine vertical F 700 mm, DN 50

Part number: 521620

GTIN: 4001636521620

Rebate group: 8

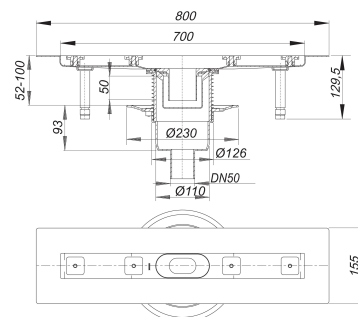
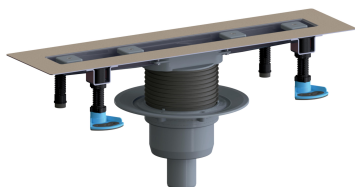

Description:

shower channel CeraLine vertical F 700 mm, DN 50
conforming to DIN EN 1253
Linear drainage, with one drain body 40 S, outlet DN 50 vertical

specification

- sound absorbing height adjustable levelling legs
- integral sand coated flange for secure bonding of under-tile waterproofing
- removable trap insert, 50 mm water seal (conforming to DIN EN 1253)
- height adjustable screws
- temporary blanking plate
- tiling gauges
- edge trim jigs

material

channel 304 stainless steel, trap polypropylene

Options for CeraLine vertical F:

- Any made-to-measure length up to 1200 mm can be supplied.
- From 900 – 1200 mm, two traps can be also be fitted for 1.4 l/sec flow rate

Please enquire!

The outlet connector can be supplied in ABS to suit British Standard sizes and PE-HD conforming to DIN EN 1519. Please enquire.

Fire protection system 2 (Part No. 515025) applicable.

Flow rates tested to DIN EN 1253:

Nominal diameter	Product standard	Min. flow rate according to norm	Water level according to norm
DN 50	DIN EN 1253	0.80 l/s	20.00 mm

09.12.2023 14:45

DALLMER

Spare parts:

523983 adjustable pedestals